

Bissell[®]

BigGreen Commercial[™]

CYCLONIC VACUUM CLEANER USER GUIDE

MODEL : BGC2000



IMPORTANT SAFETY INSTRUCTIONS

When using an electrical appliance, basic precaution should always be followed, including the following:

READ ALL INSTRUCTIONS BEFORE USING (THIS APPLIANCE)

WARNING-To reduce the risk of fire, electric shock, or injury:

1. Do not leave vacuum cleaner when plugged in. Unplug from outlet when no use and before servicing.
2. To reduce the risk of electric shock, do not use outdoors or on wet surfaces
3. Use only as described in this manual. Use only manufactures recommend attachments.
4. Do not use with damaged cord or plug. If vacuum cleaner is not working as it should, has been dropped, damaged, left outdoors, or dropped into water, enter it to a service center.
5. Do not pull or carry on cord, use cord as a handle, close door on cord, or pull cord around sharp edges or corners. Do not run vacuum cleaner over cord. Keep cord away from heated surfaces.
6. Do not unplug by pulling on cord. To unplug, grasp the plug, not the cord.
7. Do not handle plug or vacuum cleaner with wet hands.
8. Do not put any object into openings. Do not use with any opening blocked. Keep free of dust, lint, hair and anything that may reduce airflow.
- 9.Keep hair, loose clothing, fingers and all parts of body away from openings and moving parts.
- 10.Turn all controls off before unplugging.
- 11.Use extra care when cleaning on stairs.
- 12.Do not use to pick up flammable or combustible liquids, such as gasoline, or use in areas where they may be present
- 13.Hold plug when rewinding onto cord reel. Do not allow plug to whip when rewinding.
- 14.Unplug before connecting the hose
- 15.Do not pick up anything that is burning or smoking, such as cigarettes, matches, or hot ashes.
- 16.Do not use without dust bag and/or filter in place.
- 17.If the supply cord is damaged, it must be replaced by the manufacturer or its service agent or a similarly qualified person in order to avoid a hazard.

SAVE THESE INSTRUCTIONS!

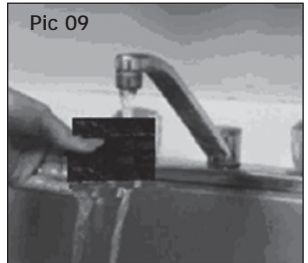
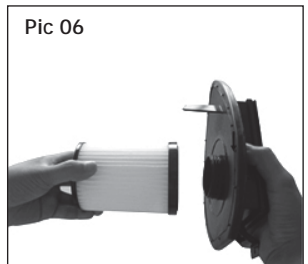
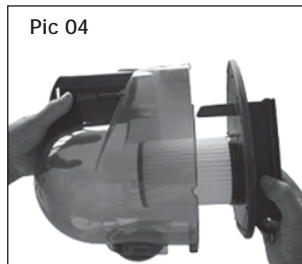
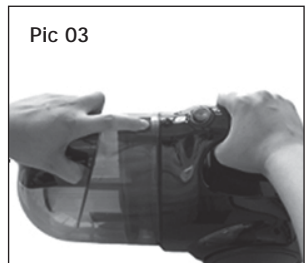
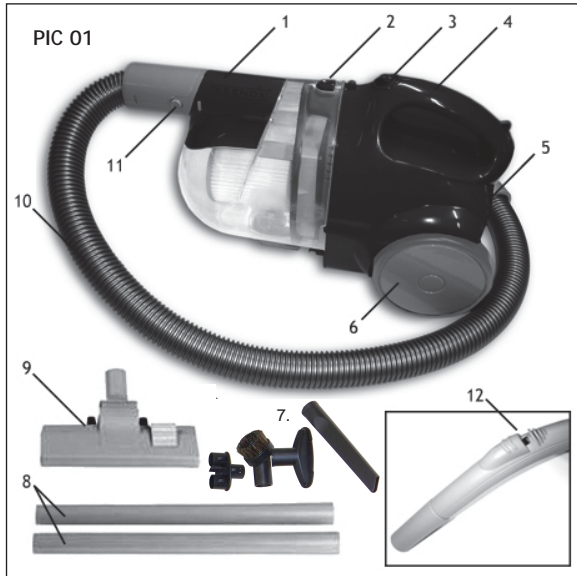

Instructions for Use

This electrical vacuum cleaner is equipped with a pipe, 2 telescopic tubes, a multi-surface roller brush and 1 double function end piece (nozzle and pivot brush). It does not require a bag and has a power of 800 watts. With its easy-to-handle design and 360° pivot function, it is uses an HEPA filter to neutralise up to 99% of dirt, bacteria and pollen (of 0.3µm diameter and above).

NOTE: Please read the instructions carefully before using the device and retain for future reference.

SPECIFIC RECOMMENDATIONS

- Before plugging in the device, check that the voltage indicated on the device corresponds to the voltage of the local power supply.
- Never use the device if the plug, power cable or device itself is damaged.
- If the power cable is damaged, it must be replaced by a qualified technician to avoid the risk of accidents occurring.
- Keep the device out of the reach of children. This device is not a toy.
- For domestic use only. Do not use outside.
- Never vacuum water, liquids, flammable substances or hot ashes.
- Never direct the pipe, tube or other accessory towards the eyes or ears.
- Never vacuum large objects as they can block the passage of air in the tubes or pipe.
- Never use the device without protection filters as you could damage the motor and reduce the lifespan of the device.
- Use only with the accessories provided with the device.
- Do not unplug the device by pulling on the power cable.
- Ensure that the device is always unplugged when not in use and before emptying.
- This appliance is not designed to be used by anyone (including children) with less than normal physical, sensory or mental capacities, or by those with no experience or understanding of electrical devices, until and unless they have been supervised or instructed in its use by someone responsible for their safety.

DESCRIPTION OF ITEM (Pic 01)

- | | |
|----------------------------|--|
| 1. Pipe connector | 7. Tool Caddy, Dusting Brush, Upholstery Tool & Crevice Tool |
| 2. Dust compartment opener | 8. Telescopic tubes |
| 3. Stop/start button | 9. Multi-surface brush |
| 4. Transport handle | 10. Pipe |
| 5. Power cable compartment | 11. Connector buttons |
| 6. Back wheels | 12. Power control adjuster |



BEFORE USE (Pic 01)

1. Insert the pipe (10) into the pipe connector hole (1).
Note: To remove the tube, press the connector buttons (11) and remove the pipe.
2. Insert the telescopic tubes (8) into the other end of the pipe (10).
3. Attach the required accessory: the flat end piece (7) or the multi-surface brush (9).

USING THE DEVICE

1. Remove the power cable from its compartment (5) and plug into a power socket.
2. Switch on the device by pressing the stop/start button (3).
3. You can adjust the suction power using the adjuster (12) on the pipe handle.

DESCRIPTION OF THE 2 ACCESSOIRES

1. **Brush (9):**
This brush can be used on various surfaces:
 - To clean hard surfaces (floors, tiling,...), activate brushes by turning the switch to position 
 - To clean soft surfaces (carpets), de-activate brushes by turning the switch to position 
2. **Double function end piece – nozzle and pivot brush (7):**
The size of the end piece means that it can be used to clean with or without the brushes in tricky places (windows, radiators). You can also fix the end piece directly onto the pipe handle (10) without the telescopic tubes (8).

CLEANING AND MAINTAINING THE FILTERS

- Always switch off and unplug the device before dismantling.
- To maintain a good level of suction, empty the dust compartment regularly.
- Never let the dust exceed the MAX level indicated on the side of the dust compartment.
- Clean the filter every time the dust compartment is emptied.
- Do not clean any part of the device in a dishwasher.

1. Detach the pipe (10) from the pipe connector hole (1). To do this, press the 2 connector buttons (11) and remove pipe (Pic 02).
2. Open the dust compartment by pressing button (2) located on the compartment (Pic 03).
3. Remove the dust compartment filter (Pic 04-05).
4. Tip dust into a bin.
5. Unscrew the cylindrical HEPA filter and rinse under clean water (Pic 06-08).
6. Remove the rectangular filter and rinse under clean water (Pic 07-09).
7. Let the filters dry naturally.

NOTE: DO NOT RE-INSERT FILTERS UNTIL THEY ARE COMPLETELY DRY.

REPAIRS

- **If the vacuum suction is insufficient:**
 - Check that the filters have not been clogged up. If necessary, clean them (see chapter on 'MAINTENANCE').
 - Check that the accessories are not blocked (end piece, tube or pipe). If necessary, carefully remove the stopper to enable the air to flow normally.
- **If the dust compartment will not close:**
 - Check that the filters have been correctly re-installed.

PROCESSING ELECTRICAL AND ELECTRONIC APPLIANCES AT THE END OF THEIR SERVICE LIFE

Application in countries of the European Union and other European countries with selective collection systems.



When this symbol is displayed on the product or its packaging, it indicates that this product must not be disposed of with household waste. It must be taken to an appropriate collection point for recycling electrical and electronic equipment.

By ensuring that this product is disposed of properly, you will help prevent the potential negative consequences for the environment and human health. Recycling materials will help preserve natural resources. For all additional information about recycling this product, please contact your local council, waste collection centre or your retailer.

Bissell BigGreen Commercial
100 Armstrong Road
Plymouth , Ma 02360

(508) 746-6106
<http://www.bissellcommercial.com/>

BISSELL® BigGreen Commercial™ Customer care

For information about repairs or replacement parts, or questions about your warranty, call:

BISSELL® BigGreen Commercial™ Customer Care
800-242-1378

Monday - Friday 8 am - 5 pm ET

Or write:

BISSELL® BigGreen Commercial™ Business Ventures, LLC.

100 Armstrong Rd Suite 101 Plymouth Ma 02360

ATTN: Customer Care

Or visit the BISSELL® BigGreen Commercial™ website -

www.bissellcommercial.com

When contacting BISSELL® BigGreen Commercial™, have model number of cleaner available.

Please record your Model Number: _____

Please record your Purchase Date: _____

BISSELL®
BigGreen Commercial™

©2013 BISSELL® BigGreen Commercial™
Business Ventures, LLC.

100 Armstrong Rd Suite 101
Plymouth Ma 02360

All rights reserved. Printed in China

Part Number 160-0963

Rev 2/13

Visit our website at:

www.bissellcommercial.com